

JVC

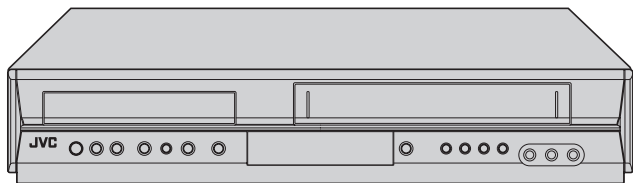

**DVD PLAYER &
VIDEO CASSETTE RECORDER**

HR-XVC18BUS HR-XVC19SUS



Hi-Fi

VHS

SQP/B

DVD
VIDEO™

dts[®]
DIGITAL OUT

DD DOLBY
DIGITAL

COMPACT
disc
DIGITAL VIDEO

COMPACT
disc
SUPER VIDEO

COMPACT
disc
DIGITAL AUDIO

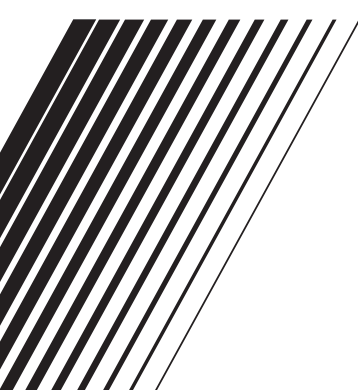

INSTRUCTIONS



CAUTION
RISK OF ELECTRIC SHOCK
DO NOT OPEN



CAUTION: TO REDUCE THE RISK OF ELECTRIC SHOCK DO NOT REMOVE COVER (OR BACK) NO USER-SERVICEABLE PARTS INSIDE REFER SERVICING TO QUALIFIED SERVICE PERSONNEL.



This lightning flash with arrowhead symbol within an equilateral triangle is intended to alert the user to the presence of uninsulated dangerous voltage within the product's enclosure that may be of sufficient magnitude to constitute a risk of electric shock to persons.



The exclamation point within an equilateral triangle is intended to alert the user to the presence of important operating and maintenance (servicing) instructions in the literature accompanying the product.

WARNING: TO PREVENT FIRE OR ELECTRIC SHOCK HAZARD, DO NOT EXPOSE THIS PRODUCT TO RAIN OR MOISTURE.

WARNING: Do not install this equipment in a confined space such as a bookcase or similar unit.

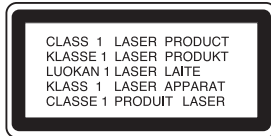

CAUTION:

This product employs a Laser System. To ensure proper use of this product, please read this owner's manual carefully and retain it for future reference. Should the unit require maintenance, contact an authorized service center. Performing controls, adjustments, or carrying out procedures other than those specified herein may result in hazardous radiation exposure. To prevent direct exposure to laser beam, do not try to open the enclosure. Visible laser radiation when open. **DO NOT STARE INTO BEAM.**

CAUTION: The apparatus should not be exposed to water (dripping or splashing) and no objects filled with liquids, such as vases, should be placed on the apparatus.

CAUTION: VISIBLE AND INVISIBLE LASER RADIATION WHEN OPEN AND INTERLOCKS DEFEATED.

FCC WARNING: This equipment may generate or use radio frequency energy. Changes or modifications to this equipment may cause harmful interference unless the modifications are expressly approved in the instruction manual. The user could lose the authority to operate this equipment if an unauthorized change or modification is made.

REGULATORY INFORMATION: FCC Part 15

This equipment has been tested and found to comply with the limits for a Class B digital device, pursuant to Part 15 of the FCC Rules. These limits are designed to provide reasonable protection against harmful interference when the product is operated in a residential installation. This product generates, uses, and can radiate radio frequency energy and, if not installed and used in accordance with the instruction manual, may cause harmful interference to radio communications. However, there is no guarantee that interference will not occur in a particular installation. If this product does cause harmful interference to radio or television reception, which can be determined by turning the product off and on, the user is encouraged to try to correct the interference by one or more of the following measures:

- Reorient or relocate the receiving antenna.
- Increase the separation between the product and receiver.
- Connect the product into an outlet on a circuit different from that to which the receiver is connected.
- Consult the dealer or an experienced radio/TV technician for help.

FCC COMPLIANCE: The responsible party for this product's compliance is:

JVC Americas Corp.
1700 Valley Road Wayne, N.J. 07470
Phone: 973-317-5000.

CAUTION concerning the Power Cord

Most appliances recommend they be placed upon a dedicated circuit;

That is, a single outlet circuit which powers only that appliance and has no additional outlets or branch circuits. Check the specification page of this owner's manual to be certain.

Do not overload wall outlets. Overloaded wall outlets, loose or damaged wall outlets, extension cords, frayed power cords, or damaged or cracked wire insulation are dangerous. Any of these conditions could result in electric shock or fire. Periodically examine the cord of your appliance, and if its appearance indicates damage or deterioration, unplug it, discontinue use of the appliance, and have the cord replaced with an exact replacement part by an authorized servicer.

Protect the power cord from physical or mechanical abuse, such as being twisted, kinked, pinched, closed in a door, or walked upon. Pay particular attention to plugs, wall outlets, and the point where the cord exits the appliance.

SERIAL NUMBER:

You can find the serial number on the back of the unit. This number is unique to this unit and not available to others. You should record requested information here and retain this guide as a permanent record of your purchase.

Model No. _____

Serial No. _____

IMPORTANT SAFETY INSTRUCTIONS

CAUTION: PLEASE READ AND OBSERVE ALL WARNINGS AND INSTRUCTIONS IN THIS OWNER'S MANUAL. AND THOSE MARKED ON THE PRODUCT. RETAIN THIS BOOKLET FOR FUTURE REFERENCE.

This product has been designed and manufactured to assure personal safety. Improper use can result in electric shock or fire hazard. The safeguards incorporated in this product will protect you if you observe the following procedures for installation, use, and servicing.

This product does not contain any parts that can be repaired by the user.

DO NOT REMOVE THE CABINET COVER, OR YOU MAY BE EXPOSED TO DANGEROUS VOLTAGE. REFER SERVICING TO QUALIFIED SERVICE PERSONNEL ONLY.

- 1. Read these instructions.** - All these safety and operating instructions should be read before the product is operated.
- 2. Keep these instructions.** - The safety, operating and use instructions should be retained for future reference.
- 3. Heed all warnings.** - All warnings on the product and in the operating instructions should be adhered to.
- 4. Follow all instructions.** - All operating and use instructions should be followed.
- 5. Do not use this product near water.** - For example: near a bath tub, wash bowl, kitchen sink, laundry tub, in a wet basement; or near a swimming pool; and other areas located near water.
- 6. Clean only with dry cloth.** - Unplug this product from the wall outlet before cleaning. Do not use liquid cleaners.
- 7. Do not block any ventilation openings. Install in accordance with the manufacturer's instructions.** - Slots and openings in the cabinet are provided for ventilation and to ensure reliable operation of the product and to protect it from over-heating. The openings should never be blocked by placing the product on a bed, sofa, rug or other similar surface. This product should not be placed in a built-in installation such as a bookcase or rack unless proper ventilation is provided or the manufacturer's instructions have been adhered to.
- 8. Do not install near any heat sources such as radiators, heat registers, stoves, or other apparatus (including amplifiers) that produce heat.**
- 9. Do not defeat the safety purpose of the polarized or grounding-type plug.** A polarized plug has two blades with one wider than the other. A grounding type plug has two blades and a third grounding prong. The wide blade or the third prong are provided for your safety. If the provided plug does not fit into your outlet, consult an electrician for replacement of the obsolete outlet.
- 10. Protect the power cord from being walked on or pinched particularly at plugs, convenience receptacles, and the point where they exit from the product.**
- 11. Only use attachments/accessories specified by the manufacturer.**
- 12. Use only with the cart, stand, tripod, bracket, or table specified by the manufacturer, or sold with apparatus. When a cart is used, use caution when moving the cart/product combination to avoid injury from tip-over.**
- 13. Unplug this product during lightning storms or when unused for long periods of time.**
- 14. Refer all servicing to qualified service personnel. Servicing is required when the product has been damaged in any way, such as power-supply cord or plug is damaged, liquid has been spilled or objects have fallen into the product, the product has been exposed to rain or moisture, does not operate normally, or has been dropped.**



Contents

Introduction	5
Moisture Condensation	5
Symbols Used in this Manual	5
About the  Symbol Display	5
Notes on Discs	5
Types of Playable Discs	6
Disc-related terms	6
Regional Code	7
Notes on Regional Codes	7
Notes on Copyrights	7
Notice for Progressive Scan Use	7
About the Remote Control	7
Selecting the Viewing Source	7
Front Panel	8
Remote Control	9
Rear Panel	10
Preparation	10
Connecting an Antenna or Cable TV	11
Basic TV Connections	11-12
Optional TV Connections	12
Audio Connection for DVD	12-13
Initial Settings - VCR	14-15
General Operation	14
CLOCK	14
• Auto Clock Set	14
• Manual Clock Set	14
PROGRAM	14
TUNING	15
• Auto Channel Programming	15
• To Add or Erase Channels	15
SETUP	15
• FUNCTION OSD	15
• AUDIO MODE	15
• BROADCAST TYPE	15
(STEREO / SAP / MONO)	15
• AUDIO OUTPUT	15
(STEREO / LEFT / RIGHT)	15
Initial Settings - DVD	16-19
General Operation	16
LANGUAGE	16
DISPLAY	17
AUDIO	18
OTHERS	19
Operation	20
VCR Tape Playback	20-21
Basic Instructions	20
Auto Tracking	20
Manual Tracking	20
Search	20
Still Picture and Frame-by-Frame Playback ..	20
Slow Motion	21
CM SKIP (Commercial Skip)	21
VHS Hi-Fi Stereo / MTS Broadcast	21
Hi-Fi Stereo Audio Sound	21
MTS (Multi-Channel TV Sound)	21
VCR Tape Recording	22-25
Basic Instructions	22
Timer Recording	22-23
Instant Timer Recording	24
Recording from External Components ..	24
Copying from DVD to VCR	25
On-Screen Display - VCR	25
Additional VCR Information	26
VCR Auto Play System	26
S-VHS Quasi Playback (SQPB)	26
Easy Information	26
Playing a DVD or Video CD	27-29
Playback Setup	27
General Features	27-29
• Moving to another TITLE	27
• Moving to another CHAPTER	27
• Slow Motion	27
• Still Picture and Frame-by-Frame Playback ..	28
• Search	28
• Time Search	28
• Marker Search	28
• Repeat	28
• Repeat A-B	28
• Zoom	28
• Changing the Audio Channel	29
• Last Scene Memory	29
• Screen Saver	29
Special DVD Features	29
• Checking the contents of DVD discs:	
Menus	29
• Title Menu	29
• Disc Menu	29
• Camera Angle	29
• Changing the Audio Language	29
• Subtitles	29
On-Screen Display - DVD	30
Maintenance and Service	30
Playing an Audio CD Disc	31
Audio CD Disc Features	31
• Pause	31
• Moving to another Track	31
• Repeat Track / All / Off	31
• Search	32
• Random	32
• Repeat A-B	32
Programmed Playback	32
Viewing a JPEG Disc	34
Slide Show	34
Still Picture	34
Moving to another File	34
Zoom	34
To rotate picture	34
Reference	35
Language Codes	35
Area Codes	35
Troubleshooting	36-37
Specifications	38
Warranty (Only in U.S.A.)	39

Introduction

To ensure proper use of this product, please read this owner's manual carefully and retain for future reference.

This manual provides information on the operation and maintenance of your DVD+VCR. Should the unit require service, contact an Authorized Service Center.

Moisture Condensation

Never operate the DVD+VCR immediately after moving it from a cold location to a warm location. Leave it unplugged for two or three hours without operating it.

If you use the DVD+VCR in such a situation, it may damage discs/tapes and internal parts.

Symbols Used in this Manual



Indicates hazards likely to cause harm to the unit itself or other material damage.

Note: Indicates special notes and operating features.

Tip: Indicates tips and hints for making the task easier.

A section whose title has one of the following symbols is applicable only to the disc represented by the symbol.

- DVD** DVD
- VCD** Video CDs
- CD** Audio CDs
- JPEG** JPEG Discs

About the Symbol Display

“” may appear on your TV display during operation and indicates that the function is not permitted by this unit or the disc or not available at that time.

Notes on Discs

Handling Discs

Do not touch the playback side of the disc. Hold the disc by the edges so that fingerprints do not get on the surface. Never stick paper or tape on the disc.



Storing Discs

After playing, store the disc in its case. Do not expose the disc to direct sunlight or sources of heat and never leave it in a parked car exposed to direct sunlight.

Cleaning Discs

Fingerprints and dust on the disc can cause poor picture quality and sound distortion. Before playing, clean the disc with a clean cloth. Wipe the disc from the center out.

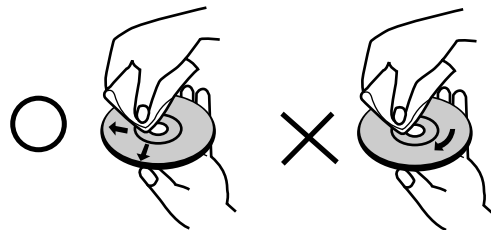

Do not use strong solvents such as alcohol, benzene, thinner, commercially available cleaners, or anti-static spray intended for older vinyl records.

Types of Playable Discs



DVD
(8 cm / 12 cm disc)



Video CD (VCD)
(8 cm / 12 cm disc)



Audio CD
(8 cm / 12 cm disc)

In addition, this unit plays DVD-R, DVD+R, DVD-RW, DVD+RW, and CD-R / CD-RW that contains audio titles, and/or JPEG files.

Notes:

- Depending on the conditions of the recording equipment or the CD-R/RW (or DVD -R, DVD +R, DVD -RW, DVD +RW) disc itself, some CD-R/RW (or DVD -R, DVD +R, DVD -RW, DVD +RW) discs cannot be played on the unit.
- DVD-RW disc can only be played if it was recorded in VIDEO mode and finalized.
- Do not attach any seal or label to either side (the labelled side or the recorded side) of a disc.
- Do not use irregularly shaped CDs (e.g., heart-shaped or octagonal) since they may result in malfunctions.

Notes on DVDs and Video CDs

Some playback operations of DVDs and Video CDs may be intentionally programmed by software manufacturers. This unit plays DVDs and Video CDs according to disc content designed by the software manufacturer, therefore some playback features may not be available or other functions may be added.

Disc-related terms

JPEG

Joint Pictures Expert Group. JPEG is a compressed file format that allows you to save images with no limit on the number of colors.

Title (DVD only)

A title is generally a distinct section of a DVD disc. For example the main feature could be title 1, a documentary describing how the film was made could be title 2, and cast interviews could be title 3. Each title is assigned a reference number enabling you to locate it easily.

Chapter (DVD only)

A chapter is a segment of a title such as a scene in a film or one interview in a series. Each chapter is assigned a chapter number, enabling you to locate the chapter you want. Depending on the disc, chapters may not be recorded.

Track

A distinct element of audio/visual information, such as the picture or sound track for a specific language (DVD), or a musical piece on a video or audio CD. Each track is assigned a track number, enabling you to locate the track you want. DVD discs allow one track of video (with multiple angles) and several tracks of audio.

Types of Video CDs

There are two types of Video CDs:

- **Video CDs equipped with PBC (Version 2.0)**
PBC (playback control) functions allow you to interact with the system via menus, search functions, or other typical computer-like operations. Moreover, still pictures of high resolution can be played if they are included in the disc.
- **Video CDs not equipped with PBC (Version 1.1)**
Operated in the same way as Audio CDs, these discs allow playback of video pictures as well as sound, but they are not equipped with PBC.

Regional Code

This DVD+VCR is designed and manufactured for playback of region "1" encoded DVD software. This unit can play only DVD discs labeled "1" or "ALL".



Notes on Regional Codes

- Most DVD discs have a globe with one or more numbers in it clearly visible on the cover. This number must match your DVD+VCR's regional code or the disc cannot play.
- If you try to play a DVD with a different region code from your player, the message "Check Regional Code" appears on the TV screen.

Notes on Copyrights:

It is forbidden by law to copy, broadcast, show, broadcast via cable, play in public, or rent copyrighted material without permission.

This product features the copy protection function developed by Macrovision. Copy protection signals are recorded on some discs. When recording and playing the pictures of these discs picture noise will appear. This product incorporates copyright protection technology that is protected by method claims of certain U.S. patents and other intellectual property rights owned by Macrovision Corporation and other rights owners. Use of this copyright protection technology must be authorized by Macrovision Corporation, and is intended for home and other limited viewing uses only unless otherwise authorized by Macrovision Corporation. Reverse engineering or disassembly is prohibited.

Notice for Progressive Scan Use

CONSUMERS SHOULD NOTE THAT NOT ALL HIGH DEFINITION TELEVISION SETS ARE FULLY COMPATIBLE WITH THIS PRODUCT AND MAY CAUSE ARTIFACTS TO BE DISPLAYED IN THE PICTURE. IN CASE OF 525 PROGRESSIVE SCAN PICTURE PROBLEMS, IT IS RECOMMENDED THAT THE USER SWITCH THE CONNECTION TO THE 'STANDARD DEFINITION' OUTPUT. IF THERE ARE QUESTIONS REGARDING OUR TV SET COMPATIBILITY WITH THIS MODEL 525p DVD+VCR, PLEASE CONTACT OUR CUSTOMER SERVICE CENTER.

About the Remote Control

Operation Range

Point the Remote Control at the remote sensor and press the buttons.

Distance: About 23 ft (7 m) from the front of the remote sensor.

Angle: About 30° in each direction of the front of the remote sensor.

Battery installation

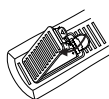

Detach the battery cover on the rear of the Remote Control, and insert two (R03/AAA) size batteries with ⊕ and ⊖ aligned correctly.



Do not mix old and new batteries and never mix different types of batteries such as standard, alkaline, etc.

Selecting the Viewing Source

You must select one of your output sources (DVD or VCR) to view on the TV screen.

- If you want to view DVD deck output source: Press DVD until DVD indicator in the display window lights and output source of DVD deck is viewed on the TV screen.
- If you want to view VCR deck output source: Press VCR until VCR indicator in the display window lights and output source of VCR deck is viewed on the TV screen.

Notes:

- If you insert a disc while the DVD+VCR is in the VCR mode, the DVD+VCR will switch to DVD mode automatically.
- If you insert a cassette tape without prevention tab while the DVD+VCR is in the DVD mode, the DVD+VCR will switch to VCR mode automatically.
- To selecting and viewing the E to E sources (tuner, line1, line2), the unit must be in VCR mode.

Manufactured under license from Dolby Laboratories. "Dolby" and the double-D symbol are trademarks of Dolby Laboratories.

DTS and DTS Digital Out are trademarks of Digital Theater Systems, Inc.

This model is equipped with SQPB (S-VHS QUASI PLAYBACK) that makes it possible to play back S-VHS recordings with regular VHS resolution.

Front Panel

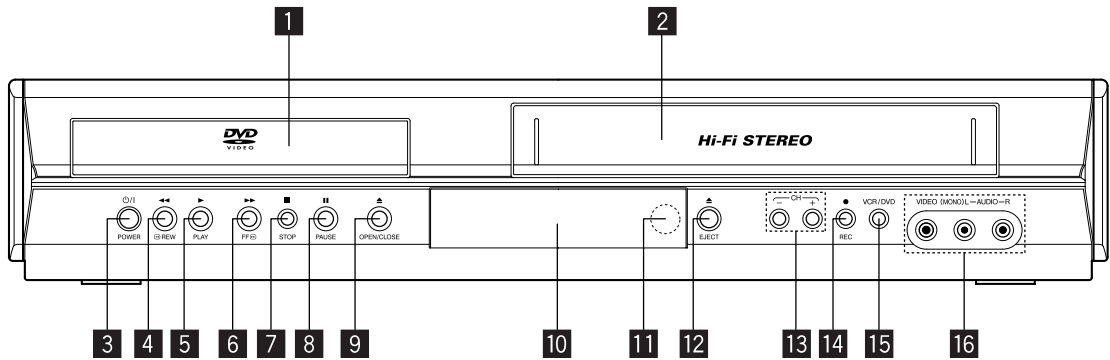

1 Disc Tray (DVD deck)

Insert a disc here.

2 Cassette Compartment (VCR deck)

Insert a video cassette here.

3 POWER

Switches the DVD+VCR ON and OFF.

4 REW

- **DVD:** Skip to beginning of current chapter or track, press twice in quick successions to go to previous chapter or track. Press and hold button for about two seconds to search backward.
- **VCR:** Rewinds the tape during the stop mode or for fast reverse picture search.

5 PLAY

Starts playback of a disc or tape.

6 FF

- **DVD:** Skip to next chapter or track. Press and hold for two seconds for a fast forward search.
- **VCR:** Advances the tape during the STOP mode or for fast forward picture search.

7 STOP

Stops playback of the disc or tape.

8 PAUSE

Pause playback or recording. Press repeatedly for frame-by-frame playback.

9 OPEN/CLOSE

Opens or closes the disc tray.

10 Display Windows

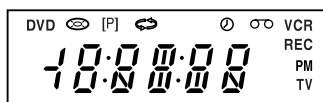

DVD The DVD deck is selected.



A disc is in the DVD deck.
(Lights when a disc is in the DVD deck and Flashes when no disc.)

[P] Indicates when the Progressive scan is active.



Indicates repeat mode.



DVD+VCR is in timer recording or a timer recording is programmed (VCR part only).



A cassette is in the VCR deck.

VCR The VCR deck is selected.

REC DVD+VCR is Recording. (VCR part only)

PM

Indicates PM time. (AM is not displayed.)

TV

Lights when TV mode is active.

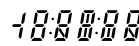

Indicates total playing time, elapsed time, remaining time or current deck status (Playback, Pause, etc).

11 Remote Sensor

Point the DVD+VCR Remote Control here.

12 EJECT

Ejects the tape in the VCR deck.

13 CH +/-

To scan up or down through memorized channels.

14 REC

To record normally or to activate One-touch Timer Recording by repeated presses.

15 VCR/DVD (output select)

Select one of your output sources to view on the TV screen between DVD and VCR.

16 LINE2 (VIDEO/AUDIO (L/R) input)

Connect to the audio/video output of an external source (Audio system, TV/Monitor, Another VCR).

Remote Control

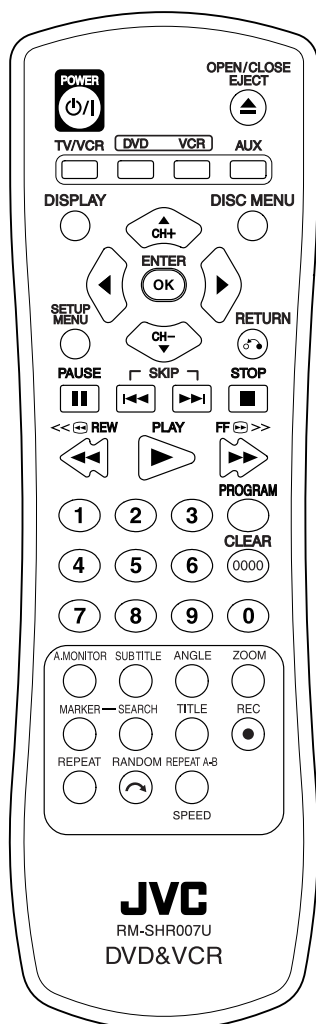

0-9 Selects numbered options in a menu.

◀ ▶ ▲ ▼ Selects menu options.

↺ Fast forwards picture search through 30 seconds of recording.

AUX Selects the VCR deck's source (Tuner, LINE 1, or LINE 2).

A.MONITOR Selects an audio language (DVD) or an audio channel (VCD).

ANGLE Selects a DVD camera angle, if available.

CH +/- Selects VCR channels. Adjusts manually the tape's picture on the TV screen.

CLEAR (0000) Removes a mark on the Marker Search menu.

DISC MENU Accesses menu on a DVD disc.

DISPLAY Accesses On-Screen Display. Switches between the clock, tape counter and tape remaining modes on the display.

DVD Select the DVD+VCR function mode to DVD.

EJECT (▲) Ejects the tape in the VCR deck.

ENTER/OK Confirms menu selections. Displays functions on the TV screen.

MARKER Marks any point during playback.

OPEN/CLOSE (▲) Opens and closes the disc tray.

PAUSE (||) Pause playback or recording. Press repeatedly for frame-by-frame playback.

PLAY (▶) Starts playback.

POWER (⏻/⏿) Switches DVD+VCR ON and OFF.

PROGRAM Shows or hides the menu for Program playback of Audio CD.

RANDOM Plays tracks in random order.

REC (●) Starts recording. Press repeatedly to set the recording time.

REPEAT Repeats chapter, track, title or all.

REPEAT A-B Repeats sequence between two points (A and B).

RETURN (↺) Removes the setup menu.

REW (◀◀)/FF (▶▶)
 - DVD: Search backward or forward.
 - VCR: Rewinds/Advances the tape during the STOP mode, for fast backward/forward picture search.

SEARCH Displays Marker Search menu.

SETUP MENU Accesses or removes DVD Setup menu and VCR menu.

SKIP (◀◀ / ▶▶) Go to next chapter or track. Returns to beginning of current chapter or track or go to previous chapter or track.

SPEED Selects recording speed.

STOP (■) Stops playback or recording.

SUBTITLE Selects a subtitle language.

TITLE Displays the disc's Title menu, if available.

TV/VCR To view channels selected by the VCR tuner or by the TV tuner.

VCR Select the DVD+VCR function mode to VCR.

ZOOM Enlarges DVD video image.

Note:

The Remote Control of a JVC TV or Receiver will not operate the unit.

Rear Panel

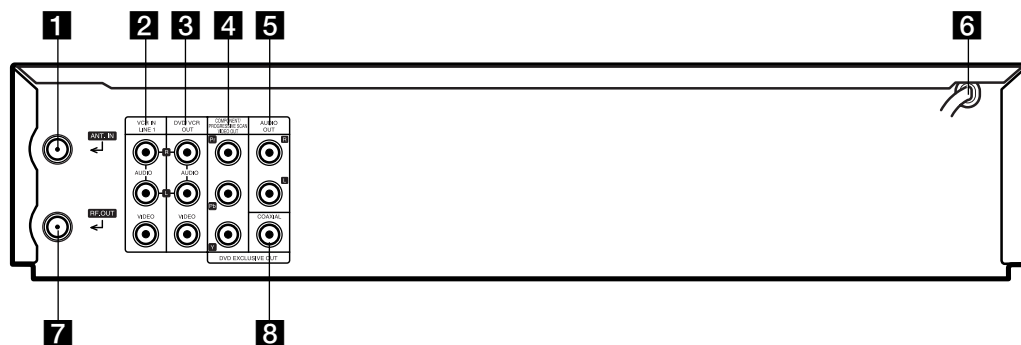

- 1 ANT.IN**
Connect the VHF/UHF/CATV antenna to this terminal.
- 2 VCR IN LINE 1 (VIDEO/AUDIO (Left/Right))**
Connect the audio/video output of an external source (Audio system, TV/Monitor, VCR, Camcorder).
- 3 DVD/VCR OUT (VIDEO/AUDIO (Left/Right))**
Connect to a TV with video and audio inputs.
- 4 COMPONENT/PROGRESSIVE SCAN VIDEO OUT (Y Pb Pr) (DVD OUT)**
Connect to a TV with Y Pb Pr inputs.
- 5 AUDIO OUT (Left/Right) (DVD OUT)**
Connect to a TV or other equipment with audio inputs.
- 6 AC Power Cord**
Plug into the power source.
- 7 RF. OUT**
Connect to a TV with RF coaxial inputs.
- 8 COAXIAL (DIGITAL AUDIO OUT jack) (DVD OUT)**
Connect to digital (coaxial) audio equipment.

Preparation

Depending on your TV and other equipment there are various ways you can connect the player. Please refer to the manuals of your TV, VCR, stereo system or other devices as necessary for additional connection information.

Notes:

- The picture and sound of a nearby TV, VCR, or radio may be distorted during playback. Position the units away from each other or turn off the unit after removing the disc.
- Make sure the DVD+VCR is connected directly to the TV and tune the TV to the correct video input channel.
- Do not connect the DVD+VCR's AUDIO OUT jack to the phone in jack (record deck) of your audio system. Do not connect the DVD+VCR via another VCR. The DVD image could be distorted by the copy protection system.

Connecting an Antenna or Cable TV

1 Antenna:

Disconnect the antenna from the rear of the TV and identify the antenna cable. If it is a round 75 ohm coaxial cable connect it directly to the jack marked ANT.IN on your DVD+VCR. If your antenna cable is flat connect it to a 300-ohm to 75-ohm antenna adaptor (not supplied) and slip the adaptor over the ANT.IN jack. Don't attempt to screw it into the DVD+VCR.

2 Cable TV:

If your cable connection has no converter or descrambler, unscrew the cable from your TV and attach it to the ANT.IN jack on the DVD+VCR. If a converter is required connect a coaxial cable from the wall jack to the IN connector on the converter, and a coaxial cable from the OUT connector on the converter to the ANT IN on your DVD+VCR. This cable hookup permits both TV and DVD+VCR operation.

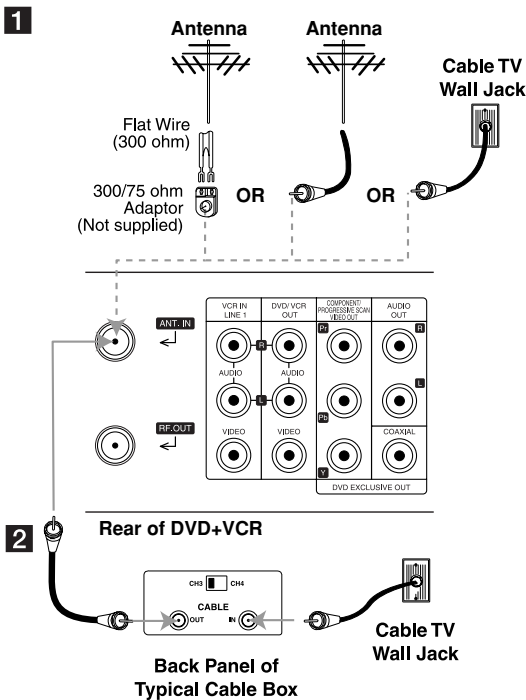

To view or record a CATV channel when using cable box

1. Tune the TV to the DVD+VCR output channel (CH 3 or 4).
2. Set the DVD+VCR channel selector to the cable output channel. (Example: CH3)
3. Select a channel using the cable converter.

Notes:

- With this connection, you cannot record one program while viewing another.
- If you are using a cable box to tune channels, it is not necessary to do Auto Channel Set.

Basic TV Connections

Make one of the following connections, depending on the capabilities of your TV.

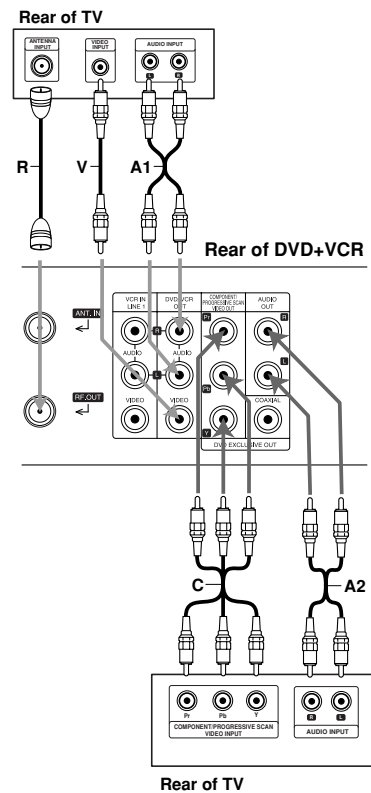

RF coaxial connection

Connect the RF.OUT jack on the DVD+VCR to the antenna in jack on the TV using the supplied 75-ohm Coaxial Cable **(R)**.

How to set the DVD+VCR's RF output channel

1. When the DVD+VCR is turned off, press and hold both CH - and CH + on the front panel for more than five seconds. "RF03" or "RF04" appears in the display window.
2. Press either CH - or CH + to change the RF output channel (RF03 or RF04). Tune the TV to this channel.
3. Turn off the DVD+VCR.

Audio/Video connection

1. Connect the DVD/VCR VIDEO OUT jack on the DVD+VCR to the video in jack on the TV using an optional video cable **(V)**.
2. Connect the Left and Right DVD/VCR AUDIO OUT jacks on the DVD+VCR to the audio left/right in jacks on the TV **(A1)** using an optional audio cables.

Note:

If you use this connection, set the TV's source selector to VIDEO.

Optional TV Connections

These connections support only DVD playback. The tuner and VCR still output through the RF.OUT **(R)** or DVD/VCR OUT **(A, V)** jacks.

Component Video / Progressive Scan connection

If your television is a high-definition or "digital ready" television, you may take advantage of the DVD+VCR's progressive scan output for the highest video resolution possible.

1. Connect the COMPONENT/PROGRESSIVE SCAN VIDEO OUT jacks on the DVD+VCR to the corresponding in jacks on the TV using an optional Y Pb Pr cable **(C)**.
2. Connect the Left and Right AUDIO OUT jacks of the DVD+VCR to the audio left/right in jacks on the TV **(A2)** using an optional audio cables.

Notes:

- When you use Composite Video signal, set the Progressive Scan to "Off" on the setup menu.
- Progressive scan does not work with the Composite video connections (yellow VIDEO OUT jack).
- If your TV does not accept the Progressive Scan format, the picture will appear scrambled. Switch to composite video output.

Audio Connection for DVD

You can listen to playback using DVD/VCR AUDIO OUT **(A1)**, AUDIO OUT **(A2)**, COAXIAL **(X)** and RF. OUT **(R)** connections. COAXIAL **(X)** and AUDIO OUT **(A2)** is used only for listening to DVD playback. (See page 11.)

Connecting to an amplifier equipped with two channel analog stereo

Connect the Left and Right AUDIO OUT (or DVD/VCR AUDIO OUT) jacks on the DVD+VCR to the audio left and right in jacks on your amplifier, receiver, or stereo system using an optional audio cables **(A1, A2)**.

Initial Settings - VCR

By using the VCR Setup menu, you can make various adjustments to items such as clock setting, and timer recordings.

Your DVD+VCR allows Remote Control adjustment of several features.

General Operation

1. Press VCR on the Remote Control.
2. Press SETUP MENU and the MAIN menu will appear.

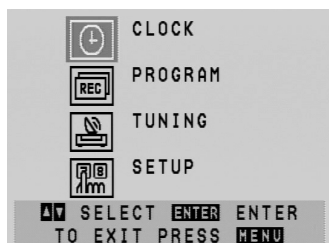

3. Use ▲ / ▼ to select the desired menu, then press ENTER / OK.
4. Use ▲ / ▼ to choose a desired option on the selected Menu. Then use ◀ / ▶ to choose a desired setting.
5. Press SETUP MENU when finished.

Note:

Menus remain on-screen for 3 minutes.

CLOCK

The DVD+VCR gives you two ways to set the time and date: the Auto Clock Feature or Manually.

Auto Clock Set

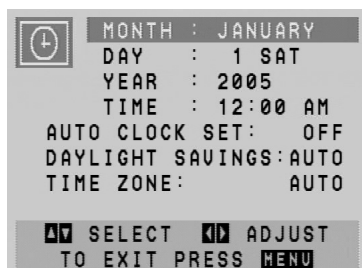

• AUTO CLOCK SET

The Auto Clock Set feature is set to ON at the factory. In the ON setting, the DVD+VCR looks for a channel carrying XDS (Extended Data Services) information. XDS updates the clock using the Coordinated Universal Time.

- Use ◀ / ▶ to choose ON or OFF.

• DAYLIGHT SAVINGS

You can turn Daylight Savings On or Off manually. If you choose "AUTO", the DVD+VCR sets the clock using the DST information broadcast in the signal (channel).

- Use ◀ / ▶ to choose AUTO, ON or OFF.

• TIME ZONE

You can set your local Time Zone manually. If you choose "AUTO", the DVD+VCR sets the clock using the first Coordinated Universal Time information it finds in a broadcast signal.

- Use ◀ / ▶ to choose the correct time zone (AUTO, EASTERN, CENTRAL, MOUNTAIN, PACIFIC, ALASKA or HAWAII).

Notes:

- The Auto Clock feature enables the DVD+VCR to set up the clock while the DVD+VCR is turned off.
- There are cases where the TV station does not send or sends wrong date and/or time information and the DVD+VCR sets the incorrect time. **If this happens we recommend that you set the clock manually.**

Manual Clock Set

Use ▲ / ▼ / ◀ / ▶ to enter the necessary information.

- MONTH : Choose the month.
- DAY : Choose the date.
The day of the week will display automatically.
- YEAR : Choose the year.
- TIME : Choose the time.
Press and hold ◀ / ▶ to advance clock continuously.

Notes:

- If setting the clock manually, "AUTO CLOCK SET" must set to "OFF". If it is left set to "ON," it will override the manual setting after the unit is turned off.
- The clock uses the 12-hour system. Be sure to set AM and PM correctly.

PROGRAM

The Timer Recording function allows you to record up to 8 programs within a period of one year. (See pages 23-24).

TUNING

This DVD+VCR is equipped with a frequency synthesized tuner capable of receiving up to 181 channels. These include VHF channels 2-13, UHF channels 14-69 and CATV channels 1-125.

Auto Channel Programming

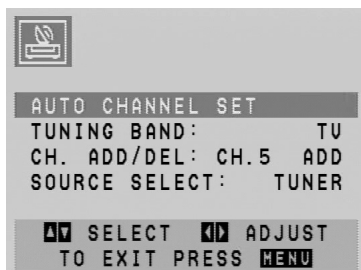

- Choose the SOURCE SELECT option, then use ◀ / ▶ to select TUNER.
Use ◀ / ▶ to switch among TUNER, LINE1, and LINE2.
- Choose the AUTO CHANNEL SET option, then use ◀ / ▶ to find channels.
 - The tuner will automatically cycle through all available channels (TV/CATV) in the area and place them in the tuner's memory.
 - After the AUTO CHANNEL SET is complete, the TUNING menu will hide and return to the TV screen automatically.
 - If the power fails or the DVD+VCR is unplugged the channel settings are kept in memory for only 3 seconds.
- Make sure the TUNING BAND is set appropriately (TV or CATV).
 - TV : If you are using a standard antenna to receive channels.
 - CATV : If you are using basic cable to receive channels.

To Add or Erase Channels

This feature allows you to add or erase channels from memory manually.

- Choose the CH. ADD/DEL option, then use ◀ / ▶ to select a channel to add or erase.
- Use ENTER / OK to add or erase the channel. Repeat steps 1 and 2 to add or erase other channels.
- Press SETUP MENU to return to the TV screen.

SETUP

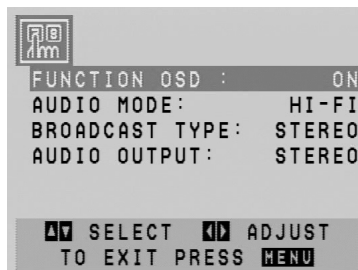

FUNCTION OSD

The on-screen display can be turned on or off.

AUDIO MODE

The DVD+VCR has two separate audio playback systems, the high quality VHS Hi-Fi system and standard NORMAL mono system. The same audio is generally recorded on both systems. The VHS Hi-Fi system plays on separate (left and right) channels, and the NORMAL system plays monaural sound. The normal track is always played so the cassette can be played on a DVD+VCR that does not have VHS Hi-Fi.

BROADCAST TYPE (STEREO / SAP / MONO)

Multichannel Television Sound (MTS) carries stereo and/or Second Audio Program (SAP) bilingual signals. Set this display to the desired position when both MTS stereo and SAP signals are received. When only one of the MTS signal is received, the DVD+VCR automatically selects the corresponding receiving mode (Stereo or SAP) regardless of the selected position. For normal operation, the display should be in the STEREO position. The DVD+VCR will then record a STEREO program when available, and record a mono program IF the program is NOT IN STEREO. For weak STEREO and/or SAP broadcasts, changing the display to mono may give clearer sound.

AUDIO OUTPUT (STEREO / LEFT / RIGHT)

Used during playback [when AUDIO MODE (HI-FI/NORMAL) is in HI-FI position] for selecting the audio output signals from the AUDIO OUT terminals (L ch and R ch), and RF.OUT. This display setting should normally be left in the stereo position, so that when a stereo tape is played, the stereo sound will be heard through the left and right channels. If a mono tape is played and the audio output is set to stereo, the same mono sound will be heard from both left and right channels. In addition to the above settings, these other sources are also affected:

- Playback of CD, DVD or VCD
- Output of built in tuner, Line 1 or Line 2

Initial Settings - DVD

By using the DVD Setup menu, you can make various adjustments to items such as picture and sound. You can also set a language for the subtitles and the Setup menu, among other things. For details on each Setup menu item, see pages 16 to 19.

To display and exit the Menu:

Press SETUP MENU to display the menu. A second press of SETUP MENU will take you back to initial screen.

To go to the next level:

Press ► on the Remote Control.

To go back to the previous level:

Press ◀ on the Remote Control.

General Operation

1. Press DVD on the Remote Control.
2. Press SETUP MENU.
The Setup menu appears.
3. Use ▲ / ▼ to select the desired option then press ► to move to the second level. The screen shows the current setting for the selected item, as well as alternate setting(s).
4. Use ▲ / ▼ to select the second desired option then press ► to move to the third level.
5. Use ▲ / ▼ to select the desired setting then press ENTER / OK to confirm your selection. Some items require additional steps.
6. Press SETUP MENU or PLAY (▶) to exit the Setup menu.

LANGUAGE

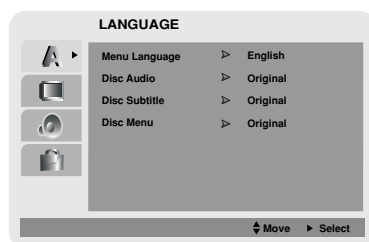

Menu Language

Select a language for the VCR and DVD's setup menu and information display.

Disc Audio / Subtitle / Menu **DVD**

Select the language you prefer for the audio track (disc audio), subtitles, and the disc menu.

Original: Refers to the original language in which the disc was recorded.

Other: To select another language, press number buttons then ENTER / OK to enter the corresponding 4-digit number according to the language code list in the reference chapter (see p. 35). If you enter the wrong language code, press CLEAR (0000).

Off (for Disc Subtitle): Turn off Subtitle.

DISPLAY

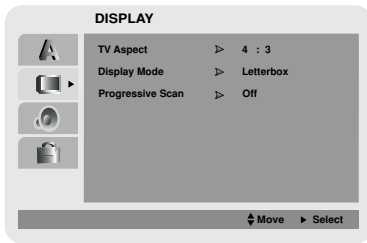

TV Aspect **DVD**

4:3 : Select when a standard 4:3 TV is connected.

16:9 : Select when a 16:9 wide TV is connected.

Display Mode **DVD**

Display Mode setting works only when the TV Aspect mode is set to "4:3".

Letterbox: Displays a wide picture with bands on the upper and lower portions of the screen.

Panscan: Automatically displays the wide picture on the entire screen and cuts off the portions that do not fit.

Progressive Scan **DVD**

Progressive Scan Video provides the highest quality pictures with less flickering.

If you are using the Component Video jacks for connection to a TV or monitor that is compatible with a progressive scan signal, set Progressive Scan to On.

To turn on progressive scan:

Connect component/progressive out of this unit to the input of your monitor/television, set your television or monitor to component/progressive Input.

1. Select "Progressive Scan" on the DISPLAY menu then press ►.
2. Select "On" using the ▲ / ▼ buttons.
3. Press ENTER / OK to confirm your selection. The confirm menu will appear.

4. When the confirm menu appears on your screen "Cancel" is highlighted as default. Use the ◀ button to highlight "Enter".

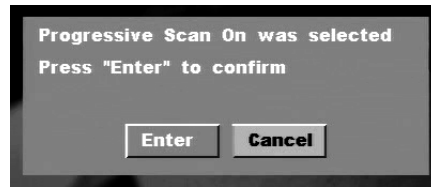

5. Pressing ENTER / OK will set this unit to progressive scan mode.

Notes:

- If you set Progressive Scan to ON in error, you must reset the DVD+VCR. Press STOP (■) and hold it for more than five seconds before releasing it. The video output will be restored to the standard setting, and a picture will once again be visible on a conventional analog TV or monitor.
- Do not turn off this DVD+VCR while the "PROGRESSIVE SCAN MODE" message is displayed in the TV screen.

AUDIO

Each DVD disc has a variety of audio output options. Set this unit's AUDIO options according to the type of audio system you use.

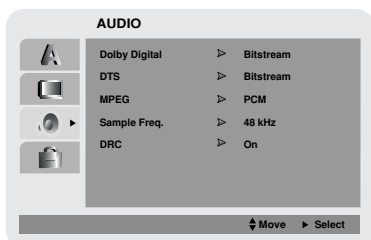

DRC (Dynamic Range Control) **DVD**

With the DVD format, you can hear a program's soundtrack in the most accurate and realistic presentation possible, thanks to digital audio technology. However, you may wish to compress the dynamic range of the audio output (the difference between the loudest sounds and the quietest ones). This allows you to listen to a movie at a lower volume without losing clarity of sound. Set DRC to On for this effect.

Dolby Digital / DTS / MPEG **DVD**

Bitstream: Select "Bitstream" if you connect the DVD+VCR's DIGITAL AUDIO OUT jack to an amplifier or other equipment with a Dolby Digital, DTS or MPEG decoder.

PCM (for Dolby Digital / MPEG): Select when connected to a two-channel digital stereo amplifier. DVDs encoded in Dolby Digital or MPEG will be automatically down-mixed to two-channel PCM audio.

Off (for DTS): If you select "Off", the DTS signal is not output through the DIGITAL AUDIO OUT jack.

Sample Freq. (Frequency) **DVD**

If your receiver or amplifier is NOT capable of handling 96 kHz signals, select 48 kHz. When this choice is made, this unit automatically converts any 96 kHz signals to 48 kHz so your system can decode them.

If your receiver or amplifier is capable of handling 96 kHz signals, select 96 kHz. When this choice is made, this unit passes each type of signal through without any further processing.

Check the documentation for your amplifier to verify its capabilities.

OTHERS

The Auto Play, and B.L.E. settings can be changed.

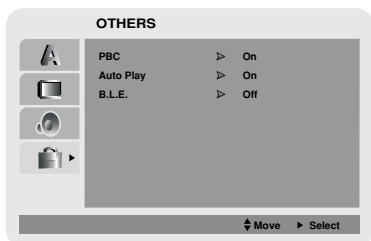

B.L.E. (Black Level Expansion)

To select the black level of playback pictures. Set your preference and monitor's ability.

On: Expanded grey scale. (0 IRE cut off)

Off: Standard grey scale. (7.5 IRE cut off)

PBC **VCD**

Set Playback Control (PBC) to On or Off.

On: Video CDs with PBC are played according to the PBC.

Off: Video CDs with PBC are played the same way as Audio CDs.

Auto Play **DVD**

You can set up the DVD+VCR so a DVD disc automatically starts playing whenever the DVD is inserted.

If Auto Play mode is set to On, this DVD player will search for title that has the longest playback time and then play back the title automatically.

On: Auto Play function is active.

Off: Auto Play function is not active.

Note:

The Auto Play function may not work for some DVDs.







Operation

This chapter describes how to operate the VCR and DVD.

VCR Tape Playback

Press the **VCR** button to select the device to be operated.

Basic Instructions

1. Turn on the TV.
2. Tune the TV to the DVD+VCR output channel (CH 3 or 4) or if a direct VIDEO/AUDIO connection is made between the DVD+VCR and the TV, set the TV's source selector to VIDEO.
3. Insert a pre-recorded video cassette. The  indicator lights and the DVD+VCR powers on automatically.
4. If the  (TIMER) indicator in the display window is lit press POWER  once.
5. If a tape without a safety tab is inserted the unit starts playback automatically. If not, press PLAY .
6. Press STOP  to stop playback. If the tape reaches the end before you press STOP  the DVD+VCR automatically stops, rewinds and ejects the tape.

Notes:

- It is not necessary to select the tape speed for playback because it is automatically selected by the DVD+VCR. Also, during playback the TV/VCR selector switches to VCR mode automatically.
- When playing back tapes that have been over-recorded with new content, the original audio may be audible during auto tracking.

Auto Tracking

Automatic tracking adjusts the picture to remove snow or streaks when:

- A tape is played for the first time.
- The tape speed (SP, LP, SLP) changes.
- Streaks or snow appear due to scratches on the tape.

Manual Tracking

To manually adjust the tracking use the CH +/- buttons during playback.



Notes:

- Vertical jitter requires a very fine adjustment.
- Tracking is automatically reset to normal when the tape is ejected or the power cord is unplugged for more than 3 seconds.

Search

This function lets you visually search for a tape section in either direction: forward and reverse. During the high-speed picture search modes, the audio is muted and horizontal lines (noise bars) appear. Also, a short time is needed to stabilize the tape speed when re-entering the PLAY mode so slight interference may be observed during this time.



To search:

1. Press REW () or FF () during playback.
2. To return to playback, press PLAY ()

Notes:

- After 3 minutes in SEARCH mode the DVD+VCR returns to PLAY mode to protect the tape and video heads.
- During the tape fast rewinding (backward or forward), don't press the same button (REW or FF) again. Otherwise it takes more time to rewind the tape.

Still Picture and Frame-by-Frame Playback

1. Press PAUSE () during playback. A still picture appears on the TV screen and the audio is muted.
2. If the still picture vibrates vertically, stabilize it by using CH +/- on the Remote Control.
3. Press PAUSE () repeatedly to advance the video picture one frame at a time.
4. To return to playback, press PLAY ()

Note:

After 5 minutes in STILL mode the DVD+VCR stops to protect the tape and video heads.

Slow Motion



1. While in still mode, press FF (▶▶). The tape is played at a speed 1/19 times slower than the normal speed.
2. Use CH +/- on the Remote Control if necessary to adjust the tracking.
3. To return to the normal speed, press PLAY (▶).

Notes:

- During slow motion, audio is muted and horizontal lines (noise bars) may appear on the TV screen. This is normal.
- After 3 minutes in SLOW MOTION mode the DVD+VCR goes back to PLAY mode to protect the tape and video heads.

CM SKIP (Commercial Skip)

This feature is useful for skipping commercials or short program segments.

1. Press  in playback mode. The DVD+VCR performs a fast forward picture search through 30 seconds of recording.
2. Press  again to extend the search time by an addition 30 seconds. The maximum search time is 3 minutes.
3. When the search is complete, the DVD+VCR goes into playback mode automatically.

VHS Hi-Fi Stereo / MTS Broadcast

This DVD+VCR is equipped with the VHS Hi-Fi audio sound system for recording and playback. The information below gives a brief description of Hi-Fi audio and how to record and play a tape in the Hi-Fi audio mode.

Hi-Fi Stereo Audio Sound

A stereo TV with AUDIO/VIDEO input jacks or a stereo audio system is required for true stereo playback. To experience the full and rich stereo sound available with Hi-Fi recorded tapes, we recommend the connection of this unit to a home stereo audio system.

1. Set the AUDIO MODE option to HI-FI on the VCR SETUP menu.

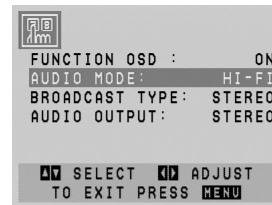

2. Set the AUDIO OUTPUT option to STEREO so that the left channel sound (L) is heard from the left speaker and the right channel sound (R) is heard from the right speaker.



The other options are (LEFT) POSITION, which results in the left channel sound (L) being heard from both speakers or (RIGHT) POSITION, which results in the right channel sound (R) being heard from both speakers.

3. Insert a cassette and press PLAY (▶).

Note:

If playing back a HI-FI tape produces noisy audio, manually change the menu setting from HI-FI to NORMAL.

MTS (Multi-Channel TV Sound)

This DVD+VCR can decode MTS stereo and bilingual (SAP) off-the-air broadcast sound signals. It also decodes stereo TV sound from local cable companies as long as they operate on assigned cable frequencies and use the EIA-recommended MTS stereo/bilingual TV sound system.

Multichannel TV Sound Indicator (MTS)

When you press ENTER / OK one or both of the indicators appears on the TV Screen.

STEREO

The DVD+VCR can record in stereo onto the VHS Hi-Fi audio tracks when the BROADCAST TYPE option is in the STEREO position. The DVD+VCR can also record mono audio onto the mono audio track.

SAP

Some stations transmit a Second Audio Program, which is used for a second language or additional information.

STEREO/SAP

Use the BROADCAST TYPE option to select the desired recording mode (STEREO or SAP).

VCR Tape Recording

Basic Instructions

1. Turn on the DVD+VCR and TV.
2. Tune the TV to the DVD+VCR output channel (CH 3 or 4) or if a direct VIDEO/AUDIO connection is made between the DVD+VCR and the TV, set the TV's source selector to VIDEO.
3. Insert a video cassette with the safety tab intact.
4. Select the desired channel using CH +/-.
5. If you are recording from another source via audio/video input jacks (at the rear or front panel), select LINE1 or LINE2 using AUX, CH + or CH -.
6. Set the desired recording speed (SP or SLP) by pressing SPEED. This DVD+VCR is not designed to record in LP mode.
7. Set the MTS mode (STEREO or SAP). Set the BROADCAST TYPE option to SAP if applicable.
8. Press REC (●) and recording starts. The REC indicator appears in the display window. If a cassette with no safety tab is loaded, the cassette is ejected.
9. Press STOP (■) to stop recording. If the tape reaches the end before STOP (■) is pressed, the DVD+VCR stops, rewinds and ejects the tape.

Tip:

Use PAUSE (||) for best results when making changes while recording. For example, if you want to change channels while recording, first press PAUSE (||) to put the unit in pause mode, select the desired channel on the DVD+VCR, and then press PAUSE (||) again to resume recording.

Note:

During the VCR recording mode, you cannot change to the DVD mode.

To pause the recording

1. Press PAUSE (||) to pause the tape during recording. The REC indicator flashes in the display window.
2. When you want to continue recording, press PAUSE (||) or press REC (●). After 5 minutes in PAUSE mode, the DVD+VCR stops automatically to protect the tape and the video heads.

To record one TV program while watching another

1. Press TV/VCR to select the TV mode during recording. The TV indicator appears.
2. Using the TV, select the channel to be viewed.

Timer Recording

For unattended recording, you must input the channels to be recorded and the starting and ending times.

Things to know before starting

If you try to set the program timer before setting the clock, "PLEASE SET THE CLOCK" appears for a moment and then CLOCK menu appears on the TV screen. Set the time and date before proceeding.

1. Turn on the DVD+VCR and the TV.
2. Be sure the TV is set to the DVD+VCR output channel (3 or 4).
3. Make sure the TUNING BAND in the TUNING menu is set appropriately (TV or CATV).
4. Press SETUP MENU and the MAIN menu appears.
5. Use ▲ / ▼ to choose the PROGRAM menu and press ENTER / OK.

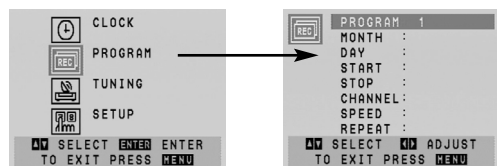

If eight programs are already entered, the FULLY PROGRAMMED message appears for a moment and then PROGRAM 1 appears on the TV screen.

6. Use the ▲ / ▼ buttons to switch between the program options, and the ◀ / ▶ buttons to input the program information:

Input the month, day, start and stop times of the program you want to record.

Channel: Select a TV channel, LINE1 or LINE2. If you have CABLE TV and use a cable box (converter) you must set the channel to match the cable box output channel (usually CH 3 or 4). Change channels on the cable box instead of with the DVD+VCR. If you use a cable converter, you can program multiple recordings only on the converter box output channel. This is because the converter determines what channel you view through your DVD+VCR.

Speed: AUTO mode determines how much tape is left and switches the speed from SP to SLP if it is necessary to complete recording the program.

If this occurs there could be some picture and sound distortion at the point where the speed changes.

Repeat: To record up to 8 programs on a certain day of every week select WEEKLY. To record up to 8 programs at the same time Monday through Friday select DAILY. Otherwise select ONCE.

7. Press SETUP MENU and the program is memorized by the DVD+VCR.
8. Additional programs may be entered by repeating steps 1-7.
9. Ensure you insert a tape with the record safety tab intact before the first programmed time.
10. Press STOP (■) to end timer recording.

Notes:

- If you make a mistake or want to change a setting, use ▲ to select the option and correct it using ◀ / ▶.
- If the program preset time is past, the "PAST TIME PROGRAMMED" message appears on the TV screen. Return to the incorrect program and program it with the correct time.
- If you enter a past date, the timer recording will be performed on that date of the next year.
- If the power fails or the DVD+VCR is unplugged the clock and timer settings are kept in memory for only 3 seconds. Otherwise you must reset the clock and timer.
- If the tape indicator is blinking, no tape is loaded.
- When you are playing DVD at programmed Recording time, the DVD+VCR automatically change to VCR mode and start recording.
- The DVD+VCR will automatically power off when Timer Recording ends.

Checking or Erasing the Timer Program

Programming can be checked whenever the DVD+VCR is turned on.

1. Press SETUP MENU and the MAIN menu appears.
2. Use ▲ / ▼ to choose the PROGRAM menu and press ENTER / OK.

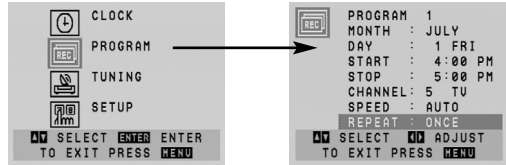

3. Use ◀ / ▶ to select a program you want to check or erase. To erase the program, press CLEAR (0000).
4. Press SETUP MENU to return to the TV screen.

Program Priority

If the recording start and end times of preset programs overlap on the same day (see the example), the second program is not recorded until the first is finished.

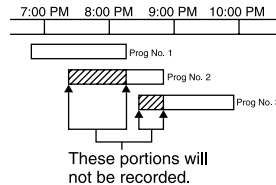

In this example, the first part of program numbers 2 and 3 are not recorded.

Instant Timer Recording

With this feature you can record for a preset length without using the program timer.

1. Turn on DVD+VCR and the TV.
2. Be sure the TV is tuned to the DVD+VCR output channel (CH 3 or 4). If a direct VIDEO/AUDIO connection is made between the DVD+VCR and the TV, set the TV's source selector to VIDEO.
3. Insert a video cassette with the safety tab intact.
4. Select the desired channel using CH +/- or the number buttons (0-9). The channel number appears on the TV screen. If you are recording from another source via audio/video input jacks (at the rear or front panel), select LINE1 (rear jacks) or LINE2 (front jacks) by using AUX.
5. Set the desired recording speed (SP or SLP) using SPEED. The tape speed appears on the TV screen.
6. Press REC (●) twice. The menu appears on the TV screen, recording starts, and the ⌚ (TIMER) indicator lights.

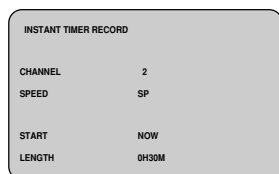

7. Press REC (●) repeatedly to select the recording time length. Each time you press this button the recording time increases 30 minutes (up to 9 hours). At the end of the recording, the DVD+VCR will stop recording and shut off.
If you set the time to 0H00M, the DVD+VCR goes into the normal recording mode. Press STOP (■) to stop the recording.

Checking the Recording Time

Press REC (●) once to check the recording time. The recalled setting automatically returns to the TV screen after 6 seconds.

Extending the Recording Time

The recording time can be extended anytime by pressing REC (●). Subsequent presses result in advancing the recording time by 30-minute increments.

Note:

If you press PAUSE (||) during instant timer recording, the instant timer recording is cancelled. It goes to normal recording PAUSE mode.

Recording from External Components

You can record from an external component, such as a camcorder or VCR, connected to any of the DVD+VCR's external inputs.

1. Make sure that the component you want to record from is connected properly to the DVD+VCR. See page 13.
2. Press AUX repeatedly to select the external input to record from.
 - LINE1 (L1): Audio/Video Input mounted on back panel.
 - LINE2 (L2): Audio/Video Input mounted on front panel.
3. Load a recordable tape.
4. Set a recording mode (SP or SLP) as necessary by pressing SPEED repeatedly.
5. Play the tape or disc in the external component.
If you have a TV attached to your DVD+VCR, you can see the video palying.
6. Press REC (●) once to start recording.
The REC indicator lights in the display window.
7. Press STOP (■) to stop recording.

Notes:

- Before recording, confirm the recording start position.
- If your source is copy-protected using CopyGuard, you will not be able to record it using this unit. See Copyright on page 7 for more details.
- To record for a fixed length of time, see Instant Timer Recording.

Copying from DVD to VCR

You can copy the contents of a DVD to a VHS tape.

1. Insert the disc you wish to copy into the DVD deck and close the disc tray.
2. Insert a blank VHS video tape into the VCR deck.
3. Find the place on the DVD from which you want to start dubbing using the PLAY, FF, REW and PAUSE functions. For best results, pause playback at the point from which you want to record.
4. Press REC (●). The DVD goes into PLAY mode and the VCR goes into RECORD mode. If the DVD disc menu appears, you may need to press PLAY (▶) manually to begin copying.
5. When the DVD is finished playing, press STOP (■) to end copying.

Notes:

- If the DVD you are attempting to copy is copy protected, you will not be able to copy the disc. It is not permitted to copy Macrovision encoded DVDs (or Discs). "Lock" is displayed in the display window.
- You must stop the copy process manually when the DVD movie ends, or the unit may replay and record over and over again.
- When you stop the DVD playback during copying, the recording on VCR is stopped automatically.
- The mark of DVD playback will be recorded at the beginning of the copied tape.
- If you press DISPLAY during copying the on-screen display will be recorded on the copied tape. Do not press any button on the remote control except when you want to stop copying.
- During this recording, do not operate the REW and FF functions. Otherwise it would record the fast moving picture without sound on the tape.

On-Screen Display - VCR

Some of these functions will be displayed every time the DVD+VCR is operated.

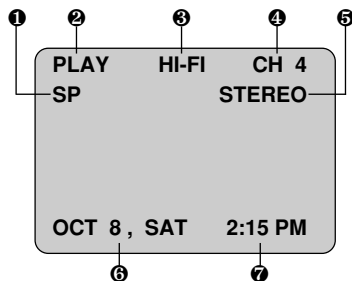

- | | |
|---|---|
| ① TAPE SPEED DISPLAY | ⑤ STEREO / SAP DISPLAY
(MONO is not displayed) |
| ② FUNCTION DISPLAY | ⑥ DATE DISPLAY |
| ③ HI-FI DISPLAY
(Only when the HI-FI audio
sound is recorded) | ⑦ CLOCK / COUNT /
REMAIN DISPLAY |
| ④ CHANNEL DISPLAY | |

Each press of ENTER/OK changes the TV screen in the following sequence.

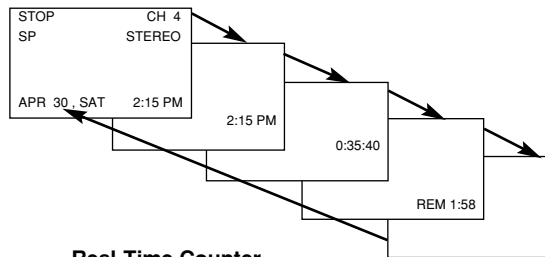

Real-Time Counter

If a tape with contents recorded on it is inserted into the VCR, the real-time counter shows length of the tape running in hours, minutes, and seconds. Press DISPLAY to select the real-time counter display. Every press of DISPLAY changes the TV screen as illustrated below.

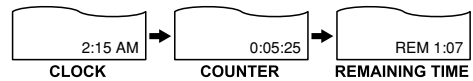

Counter Memory

This feature is useful if there is a section of tape you want to view immediately after recording or if you want to return to the same point several times.

1. Begin recording or playing a tape.
2. Press DISPLAY until the real-time counter is displayed on the TV screen.
3. At the point that you want to locate later, reset the real-time counter to "0:00:00" by pressing CLEAR (0000).
4. Continue to play or record.
5. Press STOP (■) when recording or playback finishes.
6. Press REW (◀◀). The tape automatically stops when the tape counter returns to about "0:00:00".

Tape Remaining

This function displays the amount of time remaining on the tape during recording or playback. Press DISPLAY repeatedly until the REM indicator displays on the TV screen during recording or playback.

The remaining tape length may not be displayed correctly depending on the condition of the tape and the kind of the tape (T-140, T-160, or T-210 etc.).

Notes:

- The function displays can be seen displayed on the TV screen for 5 seconds.
- The clock (or tape counter, tape remaining) mode will be displayed until you press ENTER / OK.
- The tape counter and the remaining tape length indicator appear only when a cassette is inserted. Also, the remaining tape length indicator appears after any tape operation.

Additional VCR Information

- During manual recording, timer recording, Instant Timer Recording, playback, or fast forward modes, the DVD+VCR automatically starts rewinding the tape at the end of the tape. The cassette stops at the beginning of the tape and is ejected.
- After you have finished using the DVD+VCR, rewind, eject, and remove the cassette. Place the cassette in its protective sleeve to protect it from dust. It is not necessary to rewind the cassette before removing it, but if you do, it is ready to play or record the next time you use it.
- Be sure the DVD+VCR channel selector is on the correct channel you wish to record. The channel that is being recorded can always be checked by setting the television on the DVD+VCR channel (CH 3 or 4) and pressing the TV/VCR to turn the DVD+VCR's TV indicator off.
- Do not attempt to hook up more than one television set to the DVD+VCR for either recording or playback.

VCR Auto Play System

This DVD+VCR features automatic playback.

When you load a tape with the safety tab removed the following occurs:

- The Output Source is changed to VCR mode automatically.
- The power turns on automatically and playback begins.
- At the end of the tape, the DVD+VCR stops, then rewinds.
- The tape is ejected after rewinding and the turns itself off automatically.

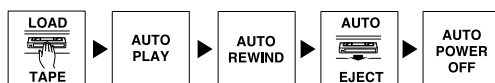

Note:

Auto power off does not function during regular DVD play mode. (DVD+VCR power stays on.)

S-VHS Quasi Playback (SQPB)

- This DVD+VCR can play back S-VHS recorded tapes, however, it cannot record video on S-VHS format.
- SQPB is an abbreviation for S-VHS Quasi Playback.

Note:

Playback picture of SQPB may be distorted in the following cases:

- When starting playback.
- When changing the playback mode between forward or reverse picture search and normal playback.
- When changing the operating deck (VCR or DVD).

Easy Information

If the Extended Data Service (XDS) signals are provided along with normal TV signal in your area or during playback of a tape recorded with Extended Data Service (XDS) signals, the station ID, program title, and program details are shown on the TV screen. When viewing a channel with Extended Data Service (XDS) signals, press ENTER / OK and the station ID will appear on the TV screen. Press ENTER / OK again and the program details will appear on the TV screen. When viewing a tape recorded with Extended Data Service (XDS) signals, press ENTER / OK twice and the program title and program details will appear on the TV screen.

Program Details

LENGTH: Indicates the run length of a program.

TIME REMAINING: Indicates the remaining time of a program.

RATING: Indicates the rating of the current program (N/A, G, PG, PG-13, R, NC-17, X and Not Rated). The rating N/A means that the motion picture ratings are not applicable to this program.

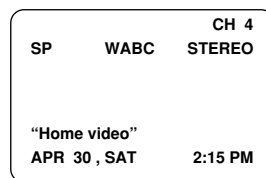

Easy Information Screen
(Station ID)

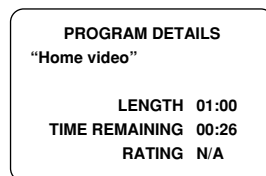

Easy Information Screen
(Program details)

Playing a DVD or Video CD

Playback Setup

1. Turn on the TV and select the video input source connected to the DVD+VCR.
2. Turn on the audio system (if applicable) and select the input source connected to the DVD+VCR.
3. Press OPEN/CLOSE (▲) to open the disc tray and load your chosen disc in the tray, with the playback side down.
4. Press OPEN/CLOSE (▲) to close the tray. Playback starts automatically. If playback does not start, press PLAY (▶).
In some cases, the disc menu might appear instead.
5. To stop the playback, press STOP (■). The unit records the stopped point, depending on the disc. "II■" appears on the screen briefly. Press PLAY (▶) to resume playback (from the scene point). If you press STOP (■) again or unload the disc ("■" appears on the screen.), the unit will clear the stopped point. Press OPEN/CLOSE (▲) to remove the disc. Press OPEN/CLOSE (▲) to close disc tray or press POWER (⏻/⏻), the disc tray closes automatically and unit turns off.

If a menu screen is displayed

The menu screen may be displayed first after loading a DVD which offer a menu.

DVD

Use the ◀ ▶ ▲ ▼ buttons to select the title/chapter you want to view, then press ENTER / OK to start. Press TITLE or DISC MENU to return to the menu screen.

VCD

Use the number buttons to select the track you want to view and press RETURN to return to the menu screen. Menu settings and operating procedures may differ. Follow the instructions on each menu screen. You also may set PBC to Off (See "PBC" on page 19).

Note:

DVDs may have a region code. Your player will not play discs that have a region code different from your player. The region code for this player is 1 (one).

General Features

Note:

Unless stated otherwise, all operations described use the Remote Control. Some features may also be available on the Setup menu.

Moving to another TITLE **DVD**

When a disc has more than one title, you can move to another title. Press DISPLAY and select desired title by using number (0-9) or ◀ / ▶ then press ENTER / OK to move to another title.

Moving to another CHAPTER **DVD** **VCD**

When a title on a disc has more than one chapter, you can move to another chapter as follows:

- Press SKIP (▶▶| or |◀◀) briefly during playback to select the next chapter or to return to the beginning of the current chapter.
- Press SKIP (|◀◀) twice in quick successions to step back to the previous chapter.
- To go directly to any chapter during DVD playback, press DISPLAY and press ▲ / ▼ to select the chapter icon. Input the chapter number (0-9) or use ◀ / ▶.

Slow Motion **DVD** **VCD**

1. Press PAUSE (||) during playback. The DVD+VCR will now go into PAUSE mode.
2. Use FF (▶▶) to select the required speed: ▶▶ 1/7, ▶▶ 1/6, ▶▶ 1/4, or ▶▶ 1/2 (forward).
3. To exit Slow Motion mode, press PLAY (▶).

Note:

Slow motion playback in reverse is not possible.

Still Picture and Frame-by-Frame Playback

DVD **VCD**

1. Press PAUSE (II) during playback. Advance the picture frame-by-frame by pressing PAUSE (II) repeatedly.
2. To exit still motion mode, press PLAY(▶).

Search **DVD** **VCD**

1. Press REW (◀◀) or FF (▶▶) during playback.
2. Press REW (◀◀) or FF (▶▶) repeatedly to select the required speed.
DVD: X2, X4, X16 or X100
VCD: X2, X4 or X8
3. To exit SEARCH mode, press PLAY (▶).

Time Search **DVD** **VCD**

To start playing at any chosen time on the disc:

1. Press DISPLAY during playback. The time search box shows the elapsed playing time.
2. Press ▲ / ▼ to select the time clock icon and “-:--:--” appears.
3. Input the required start time in hours, minutes, and seconds from left to right. If you enter the wrong numbers, press CLEAR (0000) to remove the numbers you entered. Then input the correct numbers.
4. Press ENTER / OK to confirm. Playback starts from the selected time.

Marker Search **DVD** **VCD**

To enter a Marker

You can start playback from up to nine memorized points. To enter a marker, press MARKER at the desired point on the disc. The Marker icon appears on the TV screen briefly. Repeat to enter up to nine markers.

To Recall or Clear a Marked Scene

1. During disc playback, press SEARCH. The marker search menu appears on the screen.
2. Within 10 seconds, press ◀ / ▶ to select a marker number that you want to recall or clear.
3. Press ENTER / OK and playback starts from the marked scene. Or, Press CLEAR (0000) and the marker number is erased from the list.
4. You can play any marker by inputting its number on the marker search menu.

Repeat **DVD** **VCD**

You can repeat a title/chapter on a disc. Press REPEAT during playback to select a desired repeat mode.

DVD Video Discs - Repeat Chapter / Title / Off

- Chapter: repeats the current chapter.
- Title: repeats the current title.
- Off: does not play repeatedly.

Video CDs - Repeat Track / All / Off

- Track: repeats the current track.
- All: repeats all the tracks on a disk.
- Off: does not play repeatedly.

Notes:

- On a Video CD with PBC, you must set PBC to Off on the setup menu to use this function (See “PBC” on page 19).
- If you press ▶▶I once during Repeat Chapter (Track) playback, the repeat playback cancels.

Repeat A-B **DVD** **VCD**

To repeat a sequence.

1. Press REPEAT A-B at your chosen starting point. “A - ” appears briefly on the TV screen.
2. Press REPEAT A-B again at your chosen end point. “A - B” appears briefly on the TV screen and the repeat sequence begins.
3. Press REPEAT A-B again to cancel.

Zoom **DVD** **VCD**

Use zoom to enlarge the video image.

1. Press ZOOM during playback or still playback to activate the Zoom function. The square frame appears briefly in the right bottom of the picture.
2. Each press of ZOOM changes the TV screen in the sequence: 100% size → 150% size → 200% size → 300% size → 400% size → 100% size
3. Use the ◀ ▶ ▲ ▼ buttons to move through the zoomed picture.
4. To resume normal playback, press ZOOM repeatedly or CLEAR (0000) button.

Note:

Zoom may not work on some DVDs or VCDs.

Changing the Audio Channel **VCD**

Press A.MONITOR repeatedly during playback to hear a different audio channel (Stereo, Left, Right).

Last Scene Memory **DVD** **VCD** **CD**

This player memorizes last scene from the last disc that is viewed. The last scene remains in memory even if you remove the disc from the player or switch off the player. If you load a disc that has the scene memorized, the scene is automatically recalled.

Note:

This player does not memorize the scene of a disc if you switch off the player before commencing to play the disc.

Screen Saver

The screen saver appears when you leave the DVD+VCR in Stop mode for about five minutes.

Special DVD Features

Checking the contents of DVD discs: Menus

DVDs may offer menus that allow you to access special features. To use the disc menu, press DISC MENU. Input the corresponding number or use the ◀ ▶ ▲ ▼ buttons to highlight your selection. Then press ENTER / OK.

Title Menu **DVD**

1. Press TITLE. If the current title has a menu, the menu appears on the screen. Otherwise, the disc menu may appear.
2. The menu offers features such as camera angles, spoken language and subtitle options, and chapters for the title.
3. Press TITLE to exit.

Disc Menu **DVD**

Press DISC MENU and the disc menu is displayed. Press DISC MENU again to exit.

Note:

If here the sound from line out (or RF out) only, do not select the dts sound; there is no audio from line out (or RF out) when select the dts sound mode.

Camera Angle **DVD**

If the disc contains scenes recorded at different camera angles, you can change to a different camera angle during playback. Press ANGLE repeatedly during playback to select a desired angle. Note that the number of the current angle appears on the display.

Tip:

The Camera Angle icon is displayed on the TV screen when alternate angles are available.

Changing the Audio Language **DVD**

Press A.MONITOR repeatedly during playback to hear a different audio language or audio track.

Subtitles **DVD**

Press SUBTITLE repeatedly during playback to see the different subtitle languages.

Note:

If there is no information, Ⓞ is displayed.

On-Screen Display - DVD



You can display the general playback status on the TV screen. Some items can be changed using the menu. To use the on-screen display:

1. Press DISPLAY during playback.
2. Press ▲ / ▼ to select an item. The selected item is highlighted.
3. Press ◀ / ▶ to change the setting. You can also use the number buttons if appropriate (e.g. inputting the title number). For some functions, press ENTER / OK to execute the setting.

Notes:

- Some discs may not provide all of the features shown below.
- If no button is pressed for 10 seconds, the on-screen display disappears.
- If  is displayed, action prohibited or not available.

Example: On-Screen Display during playing DVD Video

Items		Selection Method
Title Number		◀ / ▶, Numbers ENTER / OK
Chapter Number		◀ / ▶, Numbers ENTER / OK
Time search		Numbers, ENTER / OK

Maintenance and Service

Refer to the information in this chapter before contacting a service technician.

Handling the Unit

When shipping the unit

Please save the original shipping carton and packing materials. If you need to ship the unit, for maximum protection, re-pack the unit as it was originally packed at the factory.

Keeping the exterior surfaces clean

- Do not use volatile liquids such as insecticide spray near the unit.
- Do not leave rubber or plastic products in contact with the unit for a long period of time, since they leave marks on the surface.

Cleaning the unit

To clean the player, use a soft, dry cloth. If the surfaces are extremely dirty, use a soft cloth lightly moistened with a mild detergent solution.

Do not use strong solvents such as alcohol, benzene, or thinner, as these might damage the surface of the unit.

Maintaining the Unit

The DVD+VCR is a high-tech, precision device. If the optical pick-up lens and disc drive parts are dirty or worn, the picture quality could be diminished.

Depending on the operating environment, regular inspection and maintenance are recommended after every 1,000 hours of use.

For details, please contact your nearest authorized service center.

Playing an Audio CD Disc

Audio CD

Once you insert an Audio CD a menu appears on the TV screen. Press ▲ / ▼ to select a track then press PLAY (▶) or ENTER / OK and playback starts.



Audio CD Disc Features

Pause **CD**

1. Press PAUSE (||) during playback.
2. To return to playback, press PLAY (▶) or press PAUSE (||) again.

Moving to another Track **CD**

1. Press SKIP (▶▶ or ◀◀) briefly during playback to go to the next track or to return to the beginning of the current track.
2. Press SKIP (◀◀) twice in quick successions to go back to the previous track.
3. You can play any track by inputting its number.

Repeat Track / All / Off **CD**

You can play a track/all on a disc.

1. Press REPEAT when playing a disc. The repeat icon appears.
2. Press REPEAT to select a desired repeat mode.
 - Track: repeats the current track.
 - All: repeats all the tracks on a disc.
 - Off(No display): does not play repeatedly.

Note:

If you press SKIP (▶▶) once during Repeat Track playback, the repeat playback will be cancelled.

Search **CD**

1. Press REW (◀◀) or FF (▶▶) during playback.
2. Press REW (◀◀) or FF (▶▶) repeatedly to select the required speed: X2, X4 and X8 backward or forward.
3. To exit SEARCH mode, press PLAY (▶).

Random **CD**

1. Press RANDOM during playback. Random Playback begins immediately and “Random” appears on the menu screen.
2. To return to normal playback, press RANDOM repeatedly until “Random” disappears from the menu screen.

Tip:

By pressing SKIP (▶▶) or (◀◀) during random playback, the unit selects another track and resumes random playback.

Repeat A-B **CD**

1. To repeat a sequence during disc playback press REPEAT A-B at your chosen starting point. The Repeat icon and “A -” appear on the menu screen.
2. Press REPEAT A-B again at your chosen end point. The Repeat icon and “A-B” appear on the menu screen, and the sequence begins to play repeatedly.
3. To exit the sequence and return to normal play, press REPEAT A-B again. The Repeat icon disappears from the menu screen.

Programmed Playback

The program function enables you to store your favorite tracks from any disc in the player memory.

A program can contain 30 tracks.

1. Insert a disc.
AUDIO CD menu appears.
2. Press PROGRAM.
The © mark will appear to the right of the word “Program” on the right side of the menu screen.



Audio CD Program Menu

Note:

Press PROGRAM again, the © mark will disappear to exit the Program Edit mode.

3. Select a track on the “List”, then press ENTER / OK to place the selected track on the “Program” list. Repeat to place additional tracks on the list.
4. Press ▶.
Select the track you want to start playing on the “Program” list.
5. Press PLAY (▶) or ENTER / OK to start.
Playback begins in the order in which you programmed the tracks. Playback stops after all of the tracks on the “Program” list have played once.
6. To resume normal playback from programmed playback, select a track of AUDIO CD list and then press PLAY (▶).

Repeat Programmed Tracks

1. Press REPEAT when playing a disc. The repeat icon appears.
2. Press REPEAT to select a desired repeat mode.
 - Track: repeats the current track
 - All: repeats all the tracks on programmed list.
 - Off (No display): does not play repeatedly.

Note:

If you press SKIP (▶▶) once during Repeat Track playback, the repeat playback will be cancelled.

Erasing a Track from “Program” List

1. During STOP mode, press PROGRAM and Ⓢ mark will appear.
2. Use ▶ / ▲ / ▼ to select the track that you wish to erase from the Program list.
3. Press CLEAR (0000). Repeat to erase additional tracks on the list.

Erasing the Complete Program List

1. During STOP mode, press PROGRAM and Ⓢ mark will appear.
2. Use ▶ / ▲ / ▼ to select “Clear All” in the “Program” list, then press ENTER / OK.

Note:

The programs are also cleared when the disc is removed.

Viewing a JPEG Disc

Using this DVD+VCR you can view discs with JPEG files.

1. Insert a disc and close the tray. The PHOTO menu appears on the TV screen.



2. Press ▲ / ▼ to select a folder, and press ENTER / OK. A list of files in the folder appears.
If you are in a file list and want to return to the previous Folder list, use the ▲ / ▼ buttons on the remote to highlight and press ENTER / OK.
3. If you want to view a particular file, press ▲ / ▼ to highlight a file and press ENTER / OK or PLAY (▶). The selected file will appear for viewing.
While viewing a file, you can press STOP (■) to move to the previous menu (PHOTO menu).

Tips:

- Information and user guidance regarding the current image is displayed in the lower part of the screen. You can toggle this bar on and off using RETURN (↻).
- There are three Slide Speed options : >>> (Fast), >> (Normal) and > (Slow)
Use ▲▼◀▶ to highlight the Speed. Then, use ◀ / ▶ to select the option you want to use then press ENTER / OK.

Slide Show **JPEG**

Use ▲▼◀▶ to highlight the (Slide Show) then press ENTER / OK.

Still Picture **JPEG**

1. Press PAUSE (||) during slide show.
The player will now go into PAUSE mode.
2. To return to the slide show, press PLAY (▶) or press PAUSE (||) a gain.

Moving to another File **JPEG**

Press SKIP (▶▶ or ◀◀) or cursor (◀ or ▶) once while viewing a picture to advance to the next or previous file.

Zoom **JPEG**

Use zoom to enlarge the photo image. (see page 28)

To rotate picture **JPEG**

Press ▲ / ▼ during showing a picture to rotate the picture clockwise or counter clockwise.

JPEG disc compatibility with this player is limited as follows:

- Depending upon the size and number of JPEG files, it could take a long time for the DVD+VCR to read the disc's contents. If you don't see an on-screen display after several minutes, some of the files may be too large — reduce the resolution of the JPEG files to less than 5760 (Horizontal) x 3840 (Vertical) pixels and burn another disc.
- The total number of contents on the disc should be less than 1500 files and 300 folders.
- Some discs may be incompatible due to a different recording format or the condition of disc.
- Ensure that all the selected files have the “.jpg” extensions when copying into the CD layout.
- If the files have “.jpe” or “.jpeg” extensions, please rename them as “.jpg” file.
- File names without “.jpg” extension will not be able to be read by this DVD+VCR. Even though the files are shown as JPEG image files in Windows Explorer.

Reference

Language Codes

Use this list to input your desired language for the following initial settings:
Disc Audio, Disc Subtitle, Disc Menu.

Language	Code	Language	Code	Language	Code	Language	Code
Abkhazian	6566	Fiji	7074	Lingala	7678	Singhalese	8373
Afar	6565	Finnish	7073	Lithuanian	7684	Slovak	8375
Afrikaans	6570	French	7082	Macedonian	7775	Slovenian	8376
Albanian	8381	Frisian	7089	Malagasy	7771	Somali	8379
Ameharic	6577	Galician	7176	Malay	7783	Spanish	6983
Arabic	6582	Georgian	7565	Malayalam	7776	Sudanese	8385
Armenian	7289	German	6869	Maltese	7784	Swahili	8387
Assamese	6583	Greek	6976	Maori	7773	Swedish	8386
Aymara	6588	Greenlandic	7576	Marathi	7782	Tagalog	8476
Azerbaijani	6590	Guarani	7178	Moldavian	7779	Tajik	8471
Bashkir	6665	Gujarati	7185	Mongolian	7778	Tamil	8465
Basque	6985	Hausa	7265	Nauru	7865	Tatar	8484
Bengali; Bangla	6678	Hebrew	7387	Nepali	7869	Telugu	8469
Bhutani	6890	Hindi	7273	Norwegian	7879	Thai	8472
Bihari	6672	Hungarian	7285	Oriya	7982	Tibetan	6679
Breton	6682	Icelandic	7383	Panjabi	8065	Tigrinya	8473
Bulgarian	6671	Indonesian	7378	Pashto, Pushto	8083	Tonga	8479
Burmese	7789	Interlingua	7365	Persian	7065	Turkish	8482
Byelorussian	6669	Irish	7165	Polish	8076	Turkmen	8475
Cambodian	7577	Italian	7384	Portuguese	8084	Twi	8487
Catalan	6765	Japanese	7465	Quechua	8185	Ukrainian	8575
Chinese	9072	Javanese	7487	Rhaeto-Romance	8277	Urdu	8582
Corsican	6779	Kannada	7578	Rumanian	8279	Uzbek	8590
Croatian	7282	Kashmiri	7583	Russian	8285	Vietnamese	8673
Czech	6783	Kazakh	7575	Samoan	8377	Volapük	8679
Danish	6865	Kirghiz	7589	Sanskrit	8365	Welsh	6789
Dutch	7876	Korean	7579	Scots Gaelic	7168	Wolof	8779
English	6978	Kurdish	7585	Serbian	8382	Xhosa	8872
Esperanto	6979	Laothian	7679	Serbo-Croatian	8372	Yiddish	7473
Estonian	6984	Latin	7665	Shona	8378	Yoruba	8979
Faroese	7079	Latvian, Lettish	7686	Sindhi	8368	Zulu	9085

Area Codes

Choose an area code from this list.

Area	Code	Area	Code	Area	Code	Area	Code
Afghanistan	AF	Ethiopia	ET	Malaysia	MY	Saudi Arabia	SA
Argentina	AR	Fiji	FJ	Maldives	MV	Senegal	SN
Australia	AU	Finland	FI	Mexico	MX	Singapore	SG
Austria	AT	France	FR	Monaco	MC	Slovak Republic	SK
Belgium	BE	Germany	DE	Mongolia	MN	Slovenia	SI
Bhutan	BT	Great Britain	GB	Morocco	MA	South Africa	ZA
Bolivia	BO	Greece	GR	Nepal	NP	South Korea	KR
Brazil	BR	Greenland	GL	Netherlands	NL	Spain	ES
Cambodia	KH	Islands	HM	Netherlands Antilles	AN	Sri Lanka	LK
Canada	CA	Hong Kong	HK	New Zealand	NZ	Sweden	SE
Chile	CL	Hungary	HU	Nigeria	NG	Switzerland	CH
China	CN	India	IN	Norway	NO	Taiwan	TW
Colombia	CO	Indonesia	ID	Oman	OM	Thailand	TH
Congo	CG	Israel	IL	Pakistan	PK	Turkey	TR
Costa Rica	CR	Italy	IT	Panama	PA	Uganda	UG
Croatia	HR	Jamaica	JM	Paraguay	PY	Ukraine	UA
Czech Republic	CZ	Japan	JP	Philippines	PH	United States	US
Denmark	DK	Kenya	KE	Poland	PL	Uruguay	UY
Ecuador	EC	Kuwait	KW	Portugal	PT	Uzbekistan	UZ
Egypt	EG	Libya	LY	Romania	RO	Vietnam	VN
El Salvador	SV	Luxembourg	LU	Russian Federation	RU	Zimbabwe	ZW

Troubleshooting

Check the following guide for the possible cause of a problem before contacting service.

Symptom	Cause	Correction
No power.	<ul style="list-style-type: none"> The power cord is disconnected. 	<ul style="list-style-type: none"> Plug the power cord into the wall outlet securely.
The power is on, but the DVD+VCR does not work.	<ul style="list-style-type: none"> DVD or VCR button is not switched properly. 	<ul style="list-style-type: none"> Refer to page 7.
	<ul style="list-style-type: none"> No disc is inserted. No tape is inserted. 	<ul style="list-style-type: none"> Insert a disc or tape. (Check that the disc or tape indicator in the display window is lit.)
No picture.	<ul style="list-style-type: none"> The TV is not set to receive DVD + VCR signal output. 	<ul style="list-style-type: none"> Select the appropriate video input mode on the TV so the picture from the DVD+VCR player appears on the TV screen.
	<ul style="list-style-type: none"> The video cable is not connected securely. 	<ul style="list-style-type: none"> Connect the video cable into the jacks securely.
	<ul style="list-style-type: none"> Wrong connection. 	<ul style="list-style-type: none"> Check the connection.
No sound.	<ul style="list-style-type: none"> The equipment connected with the audio cable is not set to receive DVD+VCR signal output. 	<ul style="list-style-type: none"> Select the correct input mode of the audio receiver so you can listen to the sound from the DVD+VCR.
	<ul style="list-style-type: none"> The audio cables are not connected securely. 	<ul style="list-style-type: none"> Connect the audio cable into the jacks securely.
	<ul style="list-style-type: none"> The power of the equipment connected with the audio cable is turned off. 	<ul style="list-style-type: none"> Turn on the equipment connected with the audio cable.
	<ul style="list-style-type: none"> The AUDIO options are set to the wrong position. 	<ul style="list-style-type: none"> Set the AUDIO options to the correct position.
The playback picture is poor.	<ul style="list-style-type: none"> The disc is dirty. 	<ul style="list-style-type: none"> Clean the disc.
	<ul style="list-style-type: none"> The TV channels are not tuned in properly. 	<ul style="list-style-type: none"> Check tuning, carry out tuning again.
	<ul style="list-style-type: none"> Tape heads are dirty. 	<ul style="list-style-type: none"> Clean video heads.
	<ul style="list-style-type: none"> Tape is a rental or was recorded on another VCR. 	<ul style="list-style-type: none"> Use CH +/- for manual tracking adjustment while tape is playing.
	<ul style="list-style-type: none"> This unit can only output 525p Progressive scan picture. 	<ul style="list-style-type: none"> Make sure that your TV can support 525p Progressive scan picture or set Progressive scan to off.
The "PROGRESSIVE SCAN MODE" message remains to be displayed.	<ul style="list-style-type: none"> DVD+VCR was turned off while setting the Progressive scan mode. The Progressive Scan is set to On on the setup menu but is connected to a standard(analog) television with component video input. 	<ul style="list-style-type: none"> Keep pressing STOP (■) for more than 5 seconds.

Symptom	Cause	Correction
The DVD+VCR does not start playback.	• An unplayable disc is inserted.	• Insert a playable disc. (Check the disc type and Regional code.)
	• The disc is placed upside down.	• Place the disc with the playback side down.
	• The disc is not placed within the guide.	• Place the disc on the disc tray correctly inside the guide.
	• The disc is dirty.	• Clean the disc.
Video tape cannot be inserted.	• Is the cassette compartment empty?	• Eject the tape in.
No Hi-Fi sound	• Audio mode is not set properly.	• Select STEREO by repeatedly pressing A.MONITOR on the Remote Control.
The Remote Control does not work properly.	• There is an obstacle in the path of the Remote Control and this unit.	• Remove the obstacle.
	• The batteries in the Remote Control are exhausted.	• Replace the batteries with new ones.
	• The Remote Control is not pointed at the remote sensor of the DVD+VCR.	• Point the Remote Control at the remote sensor of the DVD+VCR.
	• The Remote Control is too far from the DVD+VCR.	• Operate the Remote Control within 23ft (7m).
	• This Remote Control use the same buttons for VCR and DVD functions (ex.PLAY).	• When using a VCR, first press the VCR button. When using a DVD, first press the DVD button.
	• The Remote Control of a JVC TV or Receiver cannot operate the DVD+VCR.	• Use the DVD+VCR's Remote Control.
Camcorder image is not shown.	• Camcorder is off.	• Turn camcorder on and operate properly.
Camcorder image via AV input to DVD+VCR is not shown on TV screen.	• DVD+VCR SOURCE SELECT is not set to LINE1 or LINE2.	• Press AUX to select LINE input channel (LINE1 or LINE2).
Timer recording is not possible.	• Clock in DVD+VCR is not set to correct time.	• Set clock to correct time.
	• Timer has been programmed incorrectly.	• Reprogram Timer.
	• Ⓞ indicator light does not appear after programming timer.	• Reprogram Timer and turn DVD+VCR off to enable timer.

Specifications

General

Power requirements	120 V, 60 Hz
Power consumption	16 W (POWER ON) 0.8 W (STANDBY mode)
Dimensions (approx.)	16.9" X 3.1" X 10.4" (430 X 78.5 X 265 mm) (w x h x d)
Weight (approx.)	9.24 lbs (4.2 kg)
Operating temperature	5°C to 40°C (41°F to 104°F)
Operating humidity	5 % to 90 %
Signal system	NTSC

Inputs

ANTENNA IN	75 ohms (VHF/UHF/CATV)
VHS VIDEO IN(LINE1, 2)	1 V (p-p) 75 ohms, sync negative, RCA jack x 2
VHS AUDIO IN(LINE1, 2)	-6.0 dBm more than 47 ohms, RCA jack (L, R) x 2

Outputs

VIDEO OUT	1 V (p-p) 75 ohms, sync negative
COMPONENT VIDEO OUT (PROGRESSIVE SCAN)	(Y) 1.0 V (p-p), 75 ohms, negative sync, RCA jack x 1 (Pb)/(Pr) 0.7 V (p-p), 75 ohms, RCA jack x 2
Audio output (digital audio)	0.5 V (p-p), 75 ohms, RCA jack x 1
Audio output (analog audio)	2.0 Vrms (1 KHz, 0 dB), 600 ohms, RCA jack (L, R) x 1
RF OUT	Channel 3 or 4 (Adjustable)

VCR Specifications

Head system	Four head helical scan azimuth system
Timer	12-hour display type with AM, PM
Tape speed	SP: 33.35 mm/sec, LP: 16.67 mm/sec, SLP: 11.12 mm/sec
Tape width	12.7 mm
Maximum recording time	SP: 2 HOURS (T-120), SLP: 6 HOURS (T-120)/8 HOURS (T-160)
Rewind time	About 3 minutes (T-120)
Channel coverage	VHF: 2-13, UHF: 14-69, CATV: 1-125 (4A, A-W, W+1 - W+84, A-5 - A-1)
Frequency range	20 Hz to 20 kHz
Signal-to-noise ratio	More than 43 dB
Dynamic range	More than 88 dB
Channel separation	More than 60 dB

DVD Specifications

Laser system	Semiconductor laser, wavelength 650 nm
Frequency response	DVD (PCM 96 kHz): 8 Hz to 44 kHz, DVD (PCM 48 kHz): 8 Hz to 22 kHz CD: 8 Hz to 20 kHz
Signal-to-noise ratio	More than 100 dB (ANALOG OUT jacks only)
Harmonic distortion	Less than 0.008%
Dynamic range	More than 95 dB (DVD/CD)

Accessories:

RF 75-ohm Coaxial Cable x 1, Remote control x 1, Batteries (R03/AAA) x 2

- Design and specifications are subject to change without prior notice.

Warranty (Only in U.S.A.)



LIMITED WARRANTY PORTABLE AUDIO EXCHANGE-90

JVC COMPANY OF AMERICA warrants this portable audio product and all parts thereof, except as set forth below ONLY TO THE ORIGINAL PURCHASER AT RETAIL to be FREE FROM DEFECTIVE MATERIALS AND WORKMANSHIP from the date of the original retail purchase for the period shown below. ("The Warranty Period")

LABOR 90 DAYS	PARTS 90DAYS
---------------	--------------

THIS LIMITED WARRANTY IS VALID ONLY IN THE FIFTY (50) UNITED STATES, THE DISTRICT OF COLUMBIA AND IN THE COMMONWEALTH OF PUERTO RICO.

WHAT WE WILL DO:

If this product is found to be defective within the warranty period, JVC will, at its option, either repair or replace the defective part(s) or replace the product with a new or refurbished functionally equivalent product. Within 90 days from date of retail sale, repair or replacement will be at no charge to the customer.

WHAT YOU MUST DO FOR WARRANTY SERVICE:

Please do not return your product to the retailer. Instead, please box the product carefully, preferably in the original carton, and ship, insured to the JVC repair/replacement facility nearest you.

To obtain the address of the location nearest you, please call (800) 252-5722 or visit our website at <http://www.jvc.com>

A COPY OF YOUR BILL OF SALE, A COMPLETED WARRANTY REPAIR/REPLACEMENT FORM AND ALL OF THE ORIGINAL ACCESSORIES WHICH CAME WITH YOUR UNIT MUST ACCOMPANY THE PRODUCT TO BE ELIGIBLE FOR REPAIR/REPLACEMENT UNDER WARRANTY.

If you have any questions concerning your JVC Product, please contact our Customer Care Center at (800) 252-5722.

WHAT IS EXCLUDED:

The warranty does not cover:

1. Products which have been subject to abuse, accident, alteration, modification, tampering, negligence, misuse, faulty installation, lack of reasonable care, or if repaired or serviced by anyone other than a service facility authorized by JVC to render such service, or if affixed to any attachment not provided with the products, or if the model or serial number has been altered, tampered with, defaced or removed.
2. Initial installation, installation and removal, from "built in" entertainment centers, and other mounting systems.
3. Operational adjustments covered in the Owner's Manual, normal maintenance, including head cleaning.
4. Damage that occurs in shipment, due to act of God, and cosmetic damage.
5. Signal reception problems and failures due to line power surge.
6. Products used for commercial purposes (including but not limited to rental).
7. Accessories.
8. Batteries (except that Rechargeable Batteries are covered for 90 days from the date of purchase).

There are no express warranties except as listed above.

AFTER THE WARRANTY:

Please contact JVC's Customer Care Center at (800) 252-5722 to obtain the cost of out of warranty repair or replacement.

THE DURATION OF ANY IMPLIED WARRANTIES, INCLUDING THE IMPLIED WARRANTY OF MERCHANTABILITY, IS LIMITED TO THE DURATION OF THE EXPRESS WARRANTY HEREIN.

JVC SHALL NOT BE LIABLE FOR ANY LOSS OF USE OF THE PRODUCT, INCONVENIENCE, OR ANY OTHER DAMAGES, WHETHER DIRECT, INCIDENTAL OR CONSEQUENTIAL (INCLUDING, WITHOUT LIMITATION, DAMAGE TO TAPES, RECORDS OR DISCS) RESULTING FROM THE USE OF THIS PRODUCT, OR ARISING OUT OF ANY BREACH OF THIS WARRANTY. ALL EXPRESS AND IMPLIED WARRANTIES, INCLUDING THE WARRANTIES OF MERCHANTABILITY AND FITNESS FOR PARTICULAR PURPOSE, ARE LIMITED TO THE WARRANTY PERIOD SET FORTH ABOVE.

Some states do not allow the exclusion of incidental or consequential damages or limitations on how long an implied warranty lasts, so these limitations or exclusions may not apply to you. This warranty gives you specific legal rights and you may also have other rights which vary from state to state.

JVC COMPANY OF AMERICA
DIVISION OF JVC AMERICAS CORP.

1700 Valley Road
Wayne, New Jersey 07470

<http://www.jvc.com>

REFURBISHED PRODUCTS CARRY A SEPARATE WARRANTY, THIS WARRANTY DOES NOT APPLY. FOR DETAIL OF REFURBISHED PRODUCT WARRANTY, PLEASE REFER TO THE REFURBISHED PRODUCT WARRANTY INFORMATION PACKAGED WITH EACH REFURBISHED PRODUCT.

For customer use:

Enter below the Model No. and Serial No. which is located either on the rear, bottom or side of the cabinet. Retain this information for future reference.

Model No.: _____ Serial No.: _____

Purchase Date : _____ Name Of Dealer : _____



WARRANTY REPAIR / REPLACEMENT FORM

PLEASE COMPLETE THE FOLLOWING;

PLEASE NOTE : P.O. BOXES ARE NOT ACCEPTABLE

NAME: _____

STREET ADDRESS: _____

CITY: _____ STATE _____ ZIPCODE _____

DAY TIME PHONE NUMBER: _____

REASON FOR RETURN _____

Please do not return your product to the retailer. Instead, please box the product carefully, preferably in the original carton, and ship, insured to the JVC repair/replacement facility nearest you.

A COPY OF YOUR BILL OF SALE, A COMPLETED WARRANTY REPAIR/REPLACEMENT FORM AND ALL OF THE ORIGINAL ACCESSORIES WHICH CAME WITH YOUR UNIT MUST ACCOMPANY THE PRODUCT TO BE ELIGIBLE FOR REPAIR/REPLACEMENT UNDER WARRANTY.

To obtain the address of the location nearest you, please call (800) 252-5722 or visit our website <http://www.jvc.com>.

If you have any questions concerning your JVC Product, please contact our Customer Care Center at (800) 252-5722.

BT-51025-4
(0704)

